

## Standard Recovery Diodes (Stud Version), 70 A



DO-203AB (DO-5)

### FEATURES

- High surge current capability
- Designed for a wide range of applications
- Stud cathode and stud anode version
- Leaded version available
- Types up to 1600 V  $V_{RRM}$
- Compliant to RoHS directive 2002/95/EC
- Designed and qualified for industrial level

**RoHS**  
COMPLIANT

### TYPICAL APPLICATIONS

- Converters
- Power supplies
- Machine tool controls
- Battery charges

### PRODUCT SUMMARY

$I_{F(AV)}$	70 A
-------------	------

### MAJOR RATINGS AND CHARACTERISTICS

PARAMETER	TEST CONDITIONS	70HF(R)		UNITS
		10 TO 120	140/160	
$I_{F(AV)}$		70	70	A
	$T_C$	140	110	°C
$I_{F(RMS)}$		110		A
$I_{FSM}$	50 Hz	1200		A
	60 Hz	1250		
$I^2t$	50 Hz	7100		A <sup>2</sup> s
	60 Hz	6450		
$V_{RRM}$	Range	100 to 1200	1400/1600	V
$T_J$		- 65 to 180	- 65 to 150	°C

### ELECTRICAL SPECIFICATIONS

#### VOLTAGE RATINGS

TYPE NUMBER	VOLTAGE CODE	$V_{RRM}$ , MAXIMUM REPETITIVE PEAK REVERSE VOLTAGE V	$V_{RSM}$ , MAXIMUM NON-REPETITIVE PEAK REVERSE VOLTAGE V	$V_{R(BR)}$ , MINIMUM AVALANCHE VOLTAGE V	$I_{RRM}$ MAXIMUM AT $T_J = T_J$ MAXIMUM mA
70HF(R)	10	100	200	200	15
	20	200	300	300	
	40	400	500	500	
	60	600	720	725	9
	80	800	960	950	
	100	1000	1200	1150	
	120	1200	1440	1350	
	140	1400	1650	1550	4.5
160	1600	1900	1750		

# 70HF(R) Series



Vishay High Power Products Standard Recovery Diodes  
(Stud Version), 70 A

FORWARD CONDUCTION						
PARAMETER	SYMBOL	TEST CONDITIONS		70HF(R)		UNITS
				10 TO 120	140/160	
Maximum average forward current at case temperature	$I_{F(AV)}$	180° conduction, half sine wave		70		A
				140	110	°C
Maximum RMS forward current	$I_{F(RMS)}$			110		A
Maximum peak, one cycle forward, non-repetitive surge current	$I_{FSM}$	t = 10 ms	No voltage reappplied	1200		A
		t = 8.3 ms	No voltage reappplied	1250		
		t = 10 ms	100 % $V_{RRM}$ reappplied	1000		
		t = 8.3 ms	100 % $V_{RRM}$ reappplied	1050		
Maximum $I^2t$ for fusing	$I^2t$	t = 10 ms	No voltage reappplied	7100		A <sup>2</sup> s
		t = 8.3 ms	No voltage reappplied	6450		
		t = 10 ms	100 % $V_{RRM}$ reappplied	5000		
		t = 8.3 ms	100 % $V_{RRM}$ reappplied	4550		
Maximum $I^2\sqrt{t}$ for fusing	$I^2\sqrt{t}$	t = 0.1 ms to 10 ms, no voltage reappplied		71 000		A <sup>2</sup> √s
Low level value of threshold voltage	$V_{F(TO)1}$	(16.7 % $\times \pi \times I_{F(AV)} < I < \pi \times I_{F(AV)}$ ), $T_J = T_J$ maximum		0.79		V
High level value of threshold voltage	$V_{F(TO)2}$	(I > $\pi \times I_{F(AV)}$ ), $T_J = T_J$ maximum		1.00		
Low level value of forward slope resistance	$r_{f1}$	(16.7 % $\times \pi \times I_{F(AV)} < I < \pi \times I_{F(AV)}$ ), $T_J = T_J$ maximum		2.33		mΩ
High level value of forward slope resistance	$r_{f2}$	(I > $\pi \times I_{F(AV)}$ ), $T_J = T_J$ maximum		1.53		
Maximum forward voltage drop	$V_{FM}$	$I_{pk} = 220$ A, $T_J = 25$ °C, $t_p = 400$ μs rectangular wave		1.35	1.46	V

THERMAL AND MECHANICAL SPECIFICATIONS						
PARAMETER	SYMBOL	TEST CONDITIONS		70HF(R)		UNITS
				10 TO 120	140/160	
Maximum junction and storage temperature range	$T_J, T_{Stg}$			- 65 to 180	- 65 to 150	°C
Maximum thermal resistance, junction to case	$R_{thJC}$	DC operation		0.45		K/W
Thermal resistance, case to heatsink	$R_{thCS}$	Mounting surface, smooth, flat and greased		0.25		
Maximum allowable mounting torque (+ 0 %, - 10 %)		Not lubricated thread, tightening on nut <sup>(1)</sup>		3.4	(30)	N · m (lbf · in)
		Lubricated thread, tightening on nut <sup>(1)</sup>		2.3	(20)	
		Not lubricated thread, tightening on hexagon <sup>(2)</sup>		4.2	(37)	
		Lubricated thread, tightening on hexagon <sup>(2)</sup>		3.2	(28)	
Approximate weight				17		g
				0.6		oz.
Case style		See dimensions - link at the end of datasheet		DO-203AB (DO-5)		

## Notes

(1) Recommended for pass-through holes

(2) Recommended for holed threaded heatsinks



# 70HF(R) Series

## Standard Recovery Diodes Vishay High Power Products (Stud Version), 70 A

$\Delta R_{thJC}$ CONDUCTION				
CONDUCTION ANGLE	SINUSOIDAL CONDUCTION	RECTANGULAR CONDUCTION	TEST CONDITIONS	UNITS
180°	0.08	0.06	$T_J = T_{J \text{ maximum}}$	K/W
120°	0.10	0.11		
90°	0.13	0.14		
60°	0.19	0.20		
30°	0.30	0.30		

**Note**

- The table above shows the increment of thermal resistance  $R_{thJC}$  when devices operate at different conduction angles than DC

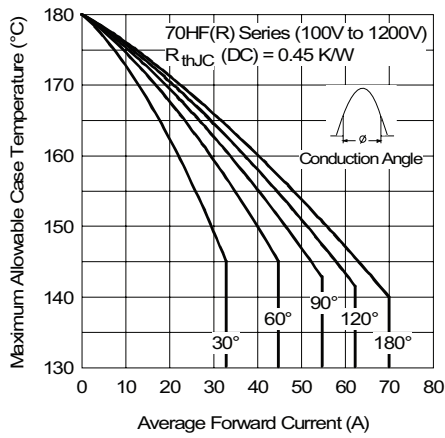

Fig. 1 - Current Ratings Characteristics

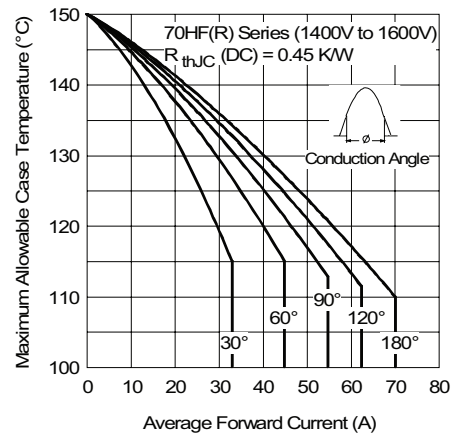

Fig. 3 - Current Ratings Characteristics

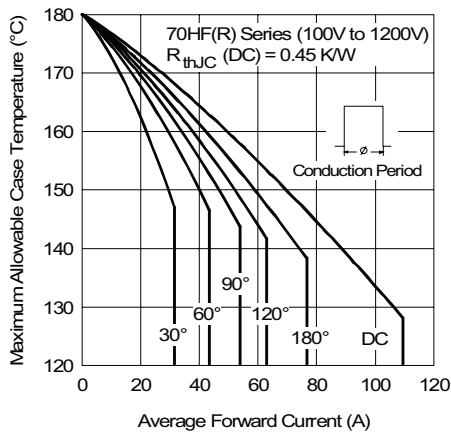

Fig. 2 - Current Ratings Characteristics

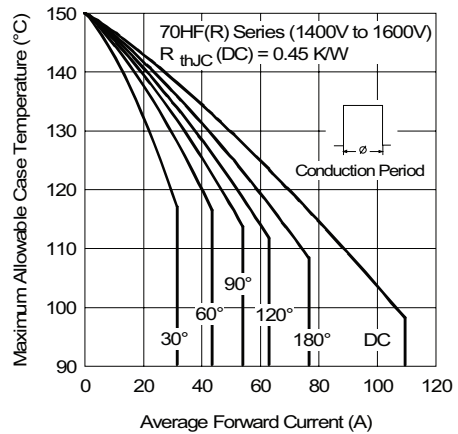

Fig. 4 - Current Ratings Characteristics

# 70HF(R) Series

Vishay High Power Products Standard Recovery Diodes  
(Stud Version), 70 A

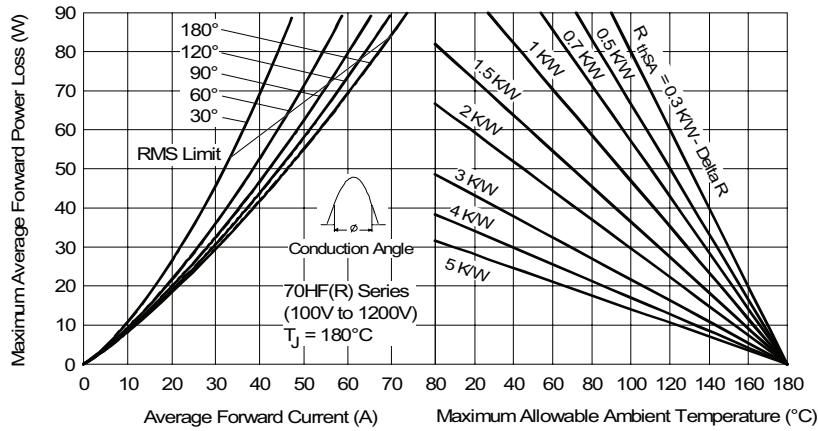

Fig. 5 - Forward Power Loss Characteristics

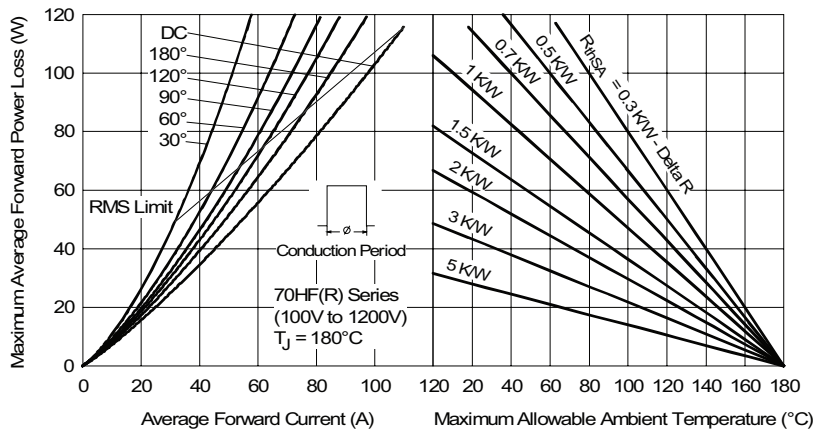

Fig. 6 - Forward Power Loss Characteristics

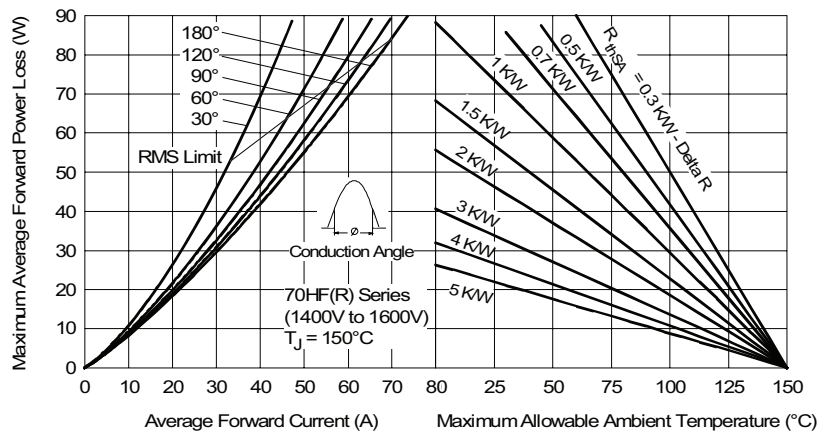

Fig. 7 - Forward Power Loss Characteristics

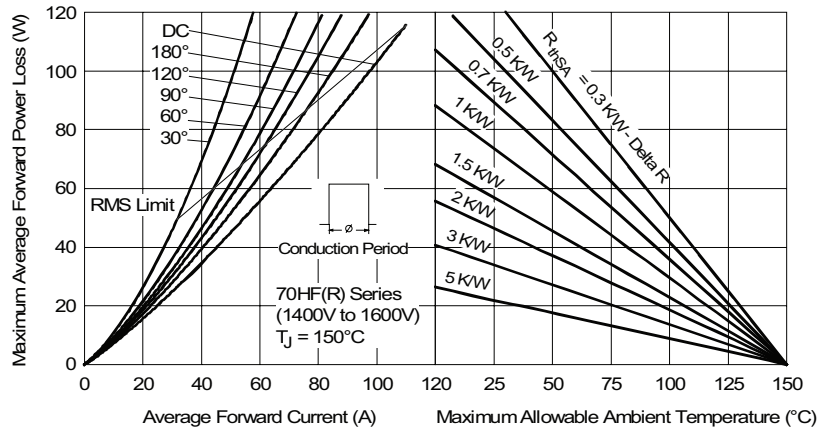

Fig. 8 - Forward Power Loss Characteristics

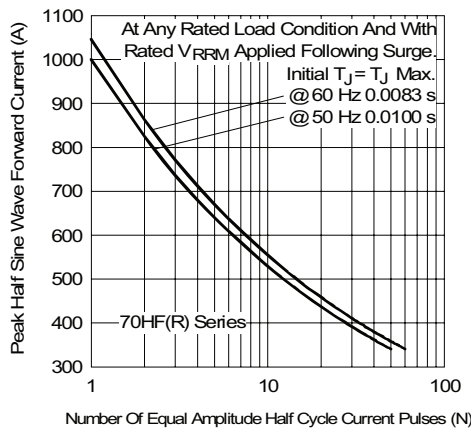

Fig. 9 - Maximum Non-Repetitive Surge Current

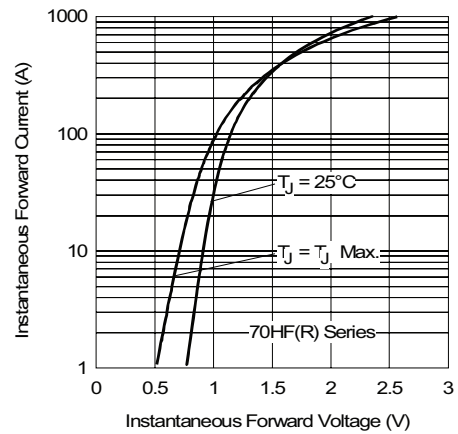

Fig. 11 - Forward Voltage Drop Characteristics

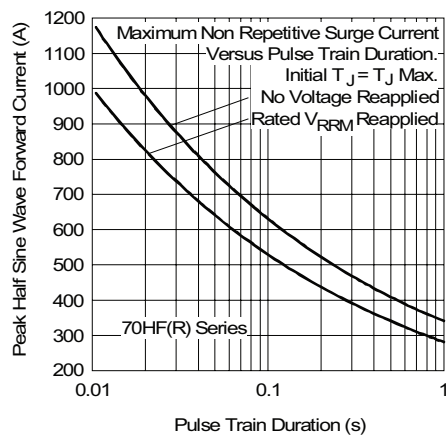

Fig. 10 - Maximum Non-Repetitive Surge Current

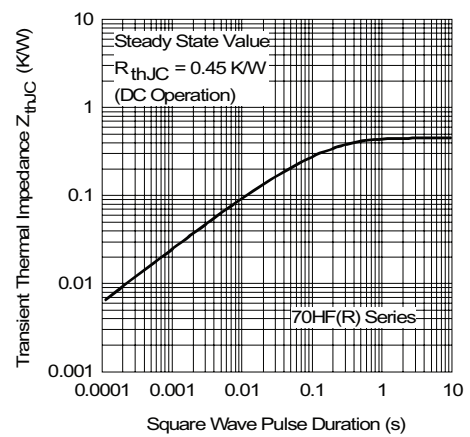

Fig. 12 - Thermal Impedance  $Z_{thJC}$  Characteristics

# 70HF(R) Series

Vishay High Power Products Standard Recovery Diodes  
(Stud Version), 70 A

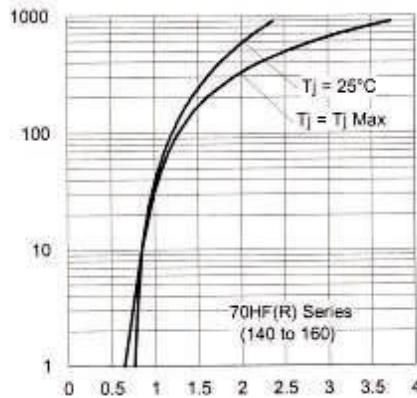

Fig. 13 - Forward Voltage Drop Characteristics

## ORDERING INFORMATION TABLE

Device code	<b>70</b>	<b>HF</b>	<b>R</b>	<b>160</b>	<b>M</b>
	①	②	③	④	⑤
<b>1</b>	-	70 = Standard device 71 = Not isolated lead 72 = Isolated lead with silicone sleeve (red = Reverse polarity) (blue = Normal polarity)			
<b>2</b>	-	HF = Standard diode			
<b>3</b>	-	• None = Stud normal polarity (cathode to stud) • R = Stud reverse polarity (anode to stud)			
<b>4</b>	-	Voltage code x 10 = $V_{RRM}$ (see Voltage Ratings table)			
<b>5</b>	-	• None = Stud base DO-203AB (DO-5) 1/4" 28UNF-2A • M = Stud base DO-203AB (DO-5) M6 x 1			



## DO-203AB (DO-5) for 70HF(R) and 71HF(R) Series

**DIMENSIONS FOR 70HF(R) SERIES** in millimeters (inches)

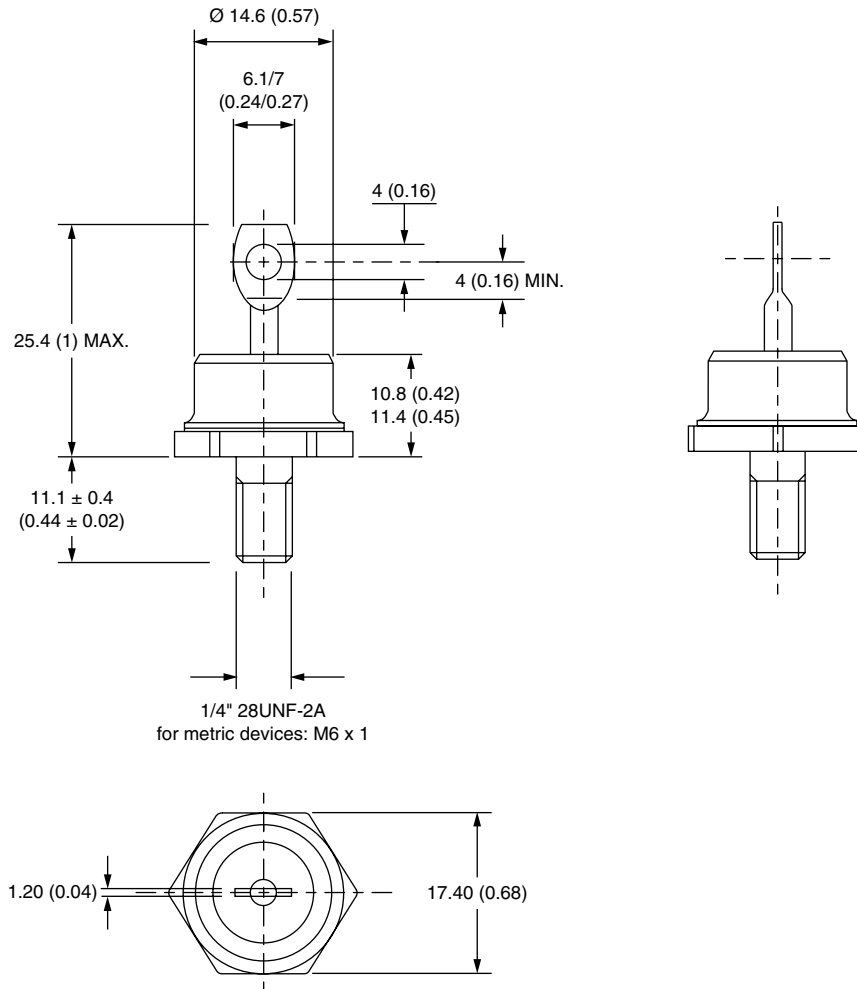

# Outline Dimensions



Vishay High Power Products DO-203AB (DO-5) for  
70HF(R) and 71HF(R) Series

## **DIMENSIONS FOR 71HF(R) SERIES** in millimeters (inches)

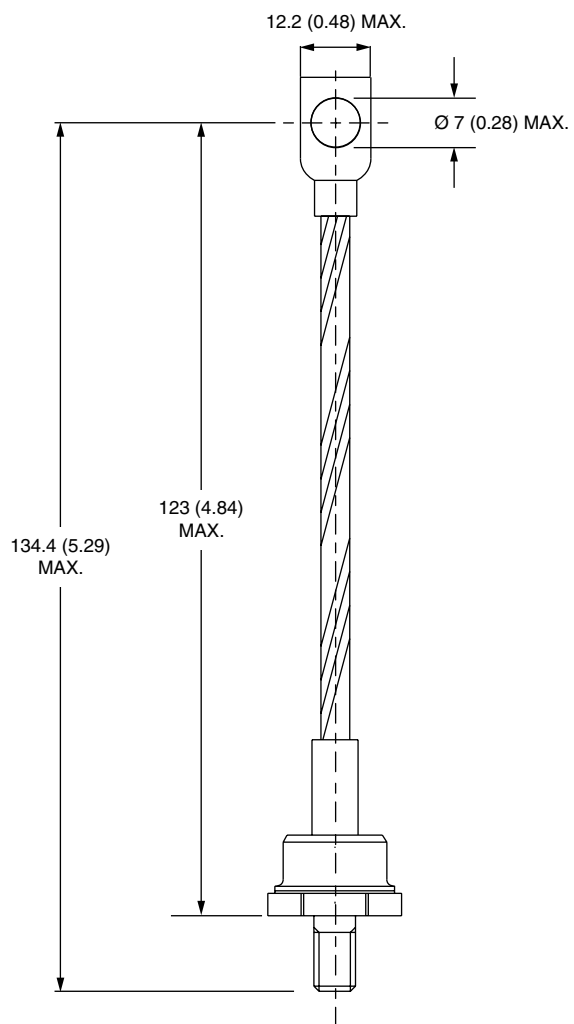





### Disclaimer

All product specifications and data are subject to change without notice.

Vishay Intertechnology, Inc., its affiliates, agents, and employees, and all persons acting on its or their behalf (collectively, "Vishay"), disclaim any and all liability for any errors, inaccuracies or incompleteness contained herein or in any other disclosure relating to any product.

Vishay disclaims any and all liability arising out of the use or application of any product described herein or of any information provided herein to the maximum extent permitted by law. The product specifications do not expand or otherwise modify Vishay's terms and conditions of purchase, including but not limited to the warranty expressed therein, which apply to these products.

No license, express or implied, by estoppel or otherwise, to any intellectual property rights is granted by this document or by any conduct of Vishay.

The products shown herein are not designed for use in medical, life-saving, or life-sustaining applications unless otherwise expressly indicated. Customers using or selling Vishay products not expressly indicated for use in such applications do so entirely at their own risk and agree to fully indemnify Vishay for any damages arising or resulting from such use or sale. Please contact authorized Vishay personnel to obtain written terms and conditions regarding products designed for such applications.

Product names and markings noted herein may be trademarks of their respective owners.